

**PREMIUM.  
POWERFUL.  
PERFORMANCE.**



**Cub Cadet**<sup>®</sup>  
Drive it...we **DARE** you!

**WE SAY DRIVE IT...WE DARE YOU BECAUSE WE KNOW YOU WILL LOVE THE POWER, CONTROL AND PRECISION ONLY A CUB CAN DELIVER.**

Cub Cadet equipment delivers the ultimate in productivity through a combination of sustained power, detailed precision and control. Innovation drives the design, engineering and function of every Cub Cadet and we've been backing this up for decades by building products that work hard at maintaining your lawn and garden.

We pride ourselves on providing you, the customer, with quality products that are comfortable to use and exceed your expectations.

Want to experience the power, precision and control for yourself? Book a test drive with your local Cub Cadet Dealer today.



SEE IT  
**IN ACTION.**

Product Details | Videos | Locate a Cub Cadet Dealer

# TABLE OF CONTENTS

XT Enduro Series™ Advantages	<b>4-5</b>
XT1 Enduro Series™	<b>6-7</b>
XT2 Enduro Series™	<b>8-9</b>
Ultima Series™	<b>10-11</b>
Ultima Series™ Advantages	<b>12-13</b>
Ultima Series™ ZT1 & ZT2	<b>14-15</b>
Ultima Series™ ZTS1	<b>16-17</b>
Ultima Series™ ZTX5	<b>18-19</b>
Ultima Series™ ZTXS	<b>20-21</b>
Electric Range Advantages	<b>22-23</b>
Electric Riders & Zero Turn	<b>24-25</b>
Commercial PRO Series	<b>26-27</b>
PRO Z Series	<b>28-29</b>
PRO Z 100 S & 500 S Series	<b>30-31</b>
PRO Z 700 S & 900 S Series	<b>32-33</b>
PRO Z 900 SD & 900 SDL Series	<b>34-35</b>
PRO Z Comfort	<b>36-37</b>
PRO Z Strength	<b>38-39</b>
PRO Z Performance	<b>40-41</b>
PRO X Series	<b>42-43</b>
Full Specifications	<b>44-51</b>

# STRENGTH BUILT INTO EVERY DETAIL.

From the moment you buy to the moment you mow, Cub Cadet is fully committed to giving you the unrivalled experience that comes with the XT Enduro Series™. Take a look at all of the XT Enduro advantages tailored to help you create your best lawn yet.



**XT1**  
ENDURO SERIES



**XT2**  
ENDURO SERIES

---

## XT ENDURO SERIES ADVANTAGES

---

- ▶ **AeroForce™ Fabricated Decks Designed to Deliver a Precise Cut**  
A heavy-duty fabricated AeroForce™ deck engineered for optimal airflow and suction that helps prevent clumping during discharge and provides excellent bagging performance (XT2 models only).
- ▶ **Responsive Handling**  
Automotive-inspired handling with an optimised steering system that delivers a one-touch, 16-inch turning radius on the XT1 and XT2.
- ▶ **Standard in Comfort**  
Adjustable high-back seats across the range and armrests available on the XT2 models, refined ergonomics and bold styling.
- ▶ **Smooth and Simple Operation**  
Hydrostatic transmission—no shifting, just push the pedal and go.

- ▶ **Excellent Support**  
An experienced national dealer network delivers dedicated personal owner support.
- ▶ **Strong Warranty**
  - 6-year domestic & 90 day commercial unit warranty
  - 6-year domestic & 90 day commercial engine warranty
- ▶ **Year-Round Attachments**  
Bagging and mulching attachments maximise the versatility of your Cub Cadet lawn tractor. Sold separately.

# A CUT ABOVE.

The next generation of ride on mowers is here. The XT1 Enduro Series™ is the industry benchmark with power, comfort, precision and control for the ultimate mowing experience. Loaded with features, the XT1 Enduro Series™ is ideally equipped for easy mowing and towing around the yard.

## ▶ Power On A Whole New Level

The XT1 LT 42 features a 547cc Cub Cadet single OHV engine with IntelliPower™ technology that provides more available power under wet, heavy loads resulting in less bogging down and more consistent cutting.

## ▶ Advanced Cutting Performance

A muscular cutting system featuring a 107cm (42") stamped deck built with heavy-duty material and an advanced belt design ensures durability and reliability while delivering the pristine Cub Cadet Signature Cut™.

## ▶ Incredibly Responsive Handling

With a tight 16" turning circle that enables you to manoeuvre around obstacles on your lawn, the XT1's steering system delivers optimised command and control at every turn.

## ▶ Added Comfort

High-back seats, comfort-grip steering and overall ergonomics are designed to keep you comfortable for extended periods.

# XT1™

## ENDURO SERIES™

### • XT1 LT 42 IntelliPower™

(See page 42 for full specifications)

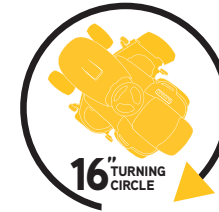

## WARRANTY

6-year unit domestic warranty. 90 day unit commercial warranty.  
6-year engine domestic warranty. 90 day engine commercial warranty.

**INTELLIPOWER™**  
OPTIMISED ENGINE TECHNOLOGY

# INTELLIPOWER™

## OPTIMIZED PERFORMANCE

The XT1® LT42 with IntelliPower™ Technology delivers up to 18% more available power\*, resulting in less bogging down when mowing in challenging conditions like tall, thick, or wet grass.

\*When compared to a Cub Cadet 547cc engine without INTELLIPOWER™ feature. Improvements vary depending on engine models and specific operating conditions.



# PREMIUM AND POWERFUL.

The XT2 Enduro Series delivers even higher levels of power, control and durability - all with a premium automotive-inspired design.

The XT2 LX 42 and LX 46 EFI models deliver smart tech features such as Electronic Fuel Injection and Push Button Start (PBS). The LX 42 Kawasaki® model's 24HP engine gives you the power to take on larger areas with ease.

## Stronger Engine Choices

The LX 42 & LX 46 EFI models feature a 679cc Cub Cadet Electronic Fuel Injected engine that helps reduce maintenance. The EFI engine also offers Push Button Start (PBS) giving you keyless starts - just push a button and go. The LX 42 Kawasaki® model features a powerful 24HP engine ideal for larger, more challenging areas.

## Comfort With Added Extras

High-back seats with armrests ensure you stay comfortable for extended periods, along with a standard front bumper, cruise control plus LED headlights for maximum visibility.

## Auto Traction Control

Automatic locking rear differential for all weather conditions and cutting terrains available on both the XT2 LX 42 EFI and the XT2 LX 46 EFI models.

## Added Durability

Front wheel bearings for low-friction tyre and wheel rotation, as well as a front bumper to help protect the front of the mower.



## WARRANTY

6-year unit domestic warranty. 90 day unit commercial warranty.  
6-year engine domestic warranty. 90 day engine commercial warranty.

# XT2 ENDURO SERIES™

- XT2 LX 42 (EFI), XT2 LX 42 (KAWASAKI®) & XT2 LX 46 (EFI)

(See page 42 for full specifications)



- XT2 LX 42  
EFI

- XT2 LX 42  
**Kawasaki**  
— ENGINES —



- XT2 LX 46  
EFI





# ULTIMA



# ULTIMA



**STEP UP TO A MOWING  
EXPERIENCE UNLIKE ANY OTHER:  
THE ULTIMA SERIES.™**

**ULTIMA SERIES**

# THE ULTIMATE ALL-AROUND MOWING EXPERIENCE.

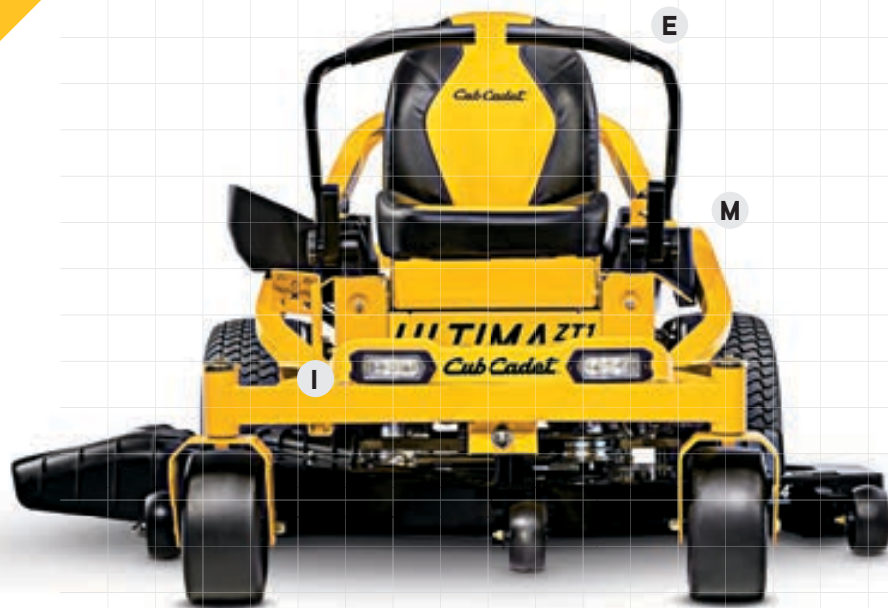

## Forged for Enhanced Strength and Durability

- A:** Continuous tubular steel frame
- B:** Premium Kawasaki® engines (ZT1, ZT2, ZTX & ZTXS models only)

## Redefined Comfort for Maximum Speed

- C:** Durable, advanced polymer seat suspension
- D:** Rubber floor mat and ample legroom
- E:** Overmolded rubber hand grips or intuitive Soft-Touch steering wheel with adjustable steering column
- F:** Automotive-inspired, ergonomic, fully adjustable high-back seat

## STEERING OPTIONS TO MEET YOUR NEEDS

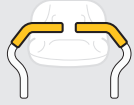

### Lap Bars

Overmolded and fully adjustable rubber hand grips generate less vibration for added comfort.



### Steering Wheel

Professional-grade Synchro-Steer™ technology, exclusive to Cub Cadet, makes for a familiar user experience as well as enhanced precision, control and stability on hills up to 20 degrees.



### Cut Quality for the Perfect Pass

- G:** Stamped and fully welded fabricated steel AeroForce™ deck options
- H:** 15 quarter-inch deck height adjustments

- I:** Offset front axle on all lap bar units for precise trimming
- J:** Premium Turf Master rear tyres

### Maintain With Ease

- K:** Maintenance-free spindles
- L:** Hinged floor pan for maintenance needs
- M:** Strong warranty, including the fabricated deck shells

# THE ZERO-TURN LEADER.

Step up to the ultimate all-around mowing experience with unrivalled strength, comfort and performance. The best-in-class cut on the Ultima Series™ ZT will bring you one step closer to your best lawn yet.

## ▶ **Tough Build**

A continuous 5cm x 5cm tubular steel frame with protective e-coat on its lower end gives you optimal durability and strength with automotive-grade corrosion resistance for long-lasting use.

## ▶ **Redefined Comfort**

An automotive-inspired, fully adjustable 51cm high-back seat (armrests available on the ZT2 54), ergonomic hand grips and a rubber floor mat let you comfortably cut at a maximum forward speed of up to 11km/h.

## ▶ **Best-In-Class Cutting Performance**

Independently tested and proven, fabricated decks in combination with 15-position deck height adjustment options and an offset front axle, deliver a best-in-class cut with fewer clumps, finer clippings and increased evenness.

## ▶ **Seamless Maintenance**

Highly accessible hinged floor pan for easy deck access and maintenance-free spindles make routine servicing quick and simple.



## WARRANTY

3-year unit domestic warranty. 90 day unit commercial warranty.  
3-year engine domestic warranty. 90 day engine commercial warranty.  
5-year fabricated deck shell domestic warranty.

## *ULTIMA SERIES™*

### THE ULTIMA SERIES™ ZT1 & ZT2

- ZT1 42, ZT1 46 & ZT2 54

(See page 43 for full specifications)



• ZT1 42

• ZT1 46

• ZT2 54



# STEER IT TO BELIEVE IT.

The Ultima ZTS brings Cub Cadet's innovative and proprietary Synchro-Steer™ technology to the proven Ultima Series™ platform for enhanced precision and confident control on challenging hills—all backed by the superior strength, comfort and cut quality of Cub Cadet.

## ▶ Effortless Control

Step up your control from traditional lap bars with Synchro-Steer™ technology. The familiar steering wheel experience plus four-wheel control makes for enhanced precision, manoeuvrability and stability on all terrain—including hills of up to 20 degrees.

## ▶ Tougher Than Tough

A continuous 5cm x 5cm tubular steel frame with protective e-coat on its lower end gives you optimal durability and strength with automotive-grade corrosion resistance for long-lasting use giving you added peace of mind.

## ▶ Best-In-Class Cutting Performance

Independently tested and proven, the fabricated decks, in combination with 15-position deck height adjustment options and an offset front axle, deliver a best-in-class cut with fewer clumps, finer clippings and increased evenness.

## ▶ First-Class Comfort

An automotive-inspired, fully adjustable 51cm high-back seat and armrests, a soft-touch steering wheel with adjustable steering column, and a rubber floor mat let you comfortably cut at your maximum speed for all day mowing.



## WARRANTY

3-year unit domestic warranty. 90 day unit commercial warranty.  
3-year engine domestic warranty. 90 day engine commercial warranty.  
5-year fabricated deck shell domestic warranty.

## ULTIMA SERIES™

### THE ULTIMA SERIES™ ZTS1

#### • ZTS1 42 & ZTS1 46

(See page 43 for full specifications)



• ZTS1 42



• ZTS1 46





Overseas model shown. Australian model features armrests.

# STEP UP TO ANY CHALLENGE.

The professional-grade build of the Ultima Series™ ZTX zero turns deliver enhanced strength and durability so you can comfortably cut at maximum speed through the most challenging conditions.

## ► Strength On Deck

Built on a 3.8cm x 7.6cm tubular frame and featuring a 10-gauge steel fabricated AeroForce Max™ deck with side, top and leading-edge reinforcements and best-in-class bagging capabilities, you will be equipped with the right amount of strength and rigidity for consistent productive mowing.

## ► Built-In Longevity

The professional-grade Kawasaki® engines are backed by a strong 3-year domestic warranty and service support from our extensive dealer network nationwide to assure the extended lifetime of your machine.

## ► Command With Comfort

Advanced polymer seat isolators, isolated front caster suspension and an automotive class 51cm high-back seat with padded armrests deliver a smooth, quiet ride at up to 13km/h with less vibration than other zero turns.

## ► Endless Versatility

With a full line-up of premium attachments and LED headlights, as well as a standard rollover protection system (ROPS) plus rear tow hitch, build the perfect zero turn package to tackle all of your needs.



## WARRANTY

3-year unit domestic warranty. 2-year unit commercial warranty.  
3-year engine domestic warranty. 2-year engine commercial warranty.  
5-year fabricated deck shell domestic warranty.

## ULTIMA SERIES™

### THE ULTIMA SERIES™ ZTX5

- ZTX5 48, ZTX5 54 & ZTX5 60

(See page 44 for full specifications)



• ZTX5 48



• ZTX5 54



• ZTX5 60



# STEP UP TO STEERING.

Introducing the Cub Cadet® Ultima ZTXS, the machine that brings proprietary Synchro-Steer™ technology to the proven Ultima Series platform. Engineered for precision and confident control on varying terrain and challenging hills - all backed by the strength, comfort and cut quality of a Cub Cadet zero turn. The commercial-grade features of the Ultima ZTXS range is designed for fast turning and efficient manoeuvrability through challenging conditions.

## ▶ Excellent Control

Step up your control from traditional lap bars with Synchro-Steer™ technology. The familiar steering wheel combined with four-wheel control makes for precision, manoeuvrability and stability on a variety of terrains including hills up to 20 degrees.

## ▶ Strength on Deck

Built on a 3.8cm x 7.6cm tubular frame featuring a 10-gauge steel fabricated AeroForce Max™ deck with side, top and leading-edge reinforcements and bagging capabilities, you're equipped with the right amount of strength and rigidity for precise cut quality.

## ▶ Versatility

With a full lineup of attachments and LED headlights as well as a standard rollover protection system (ROPS) plus rear tow hitch, you can build the ideal zero-turn to tackle your needs.

## ▶ Command With Comfort

Polymer seat isolators, isolated front caster suspension and a high-back seat in 51cm or 61cm options with padded armrests designed for a smooth and quiet ride up to 13.7km/h with minimal vibration.



## WARRANTY

3-year unit domestic warranty. 2-year unit commercial warranty.  
3-year engine domestic warranty. 2-year engine commercial warranty.  
5-year fabricated deck shell domestic warranty.

## ULTIMA SERIES™

### THE ULTIMA SERIES™ ZTXS

- ZTXS4 48, ZTXS4 54, ZTXS5 54 & ZTXS5 60

(See page 45 for full specifications)



• ZTXS4 54



• ZTXS5 60



RESIDENTIAL: ULTIMA ZTXS SERIES™

**Cub Cadet**

# BATTERY POWERED. EMPHASIS ON POWER.

Your lawn care depends on strong equipment, and our electric lineup won't let you down. Each piece is engineered with the same uncompromising commitment to design, comfort and performance we demand from every product.





**FLEXIBLE CHARGING SYSTEM.**

Get a lightning-fast charge from a standard 110V outlet without waiting overnight. In a pinch, charge to the exact power you need without risking battery damage.



**100% EMISSION-FREE EQUIPMENT WHEN MOWING.**

No exhaust, carbon monoxide or unburned hydrocarbons from the on-board power source for cleaner operation.



**NO PETROL. NO OIL. NO HASSLES.**

Less time getting ready to cut means more time enjoying your yard.



**SIGNIFICANTLY QUIETER THAN GAS.**

Cut at dawn or dusk without disturbing the neighborhood.

**ELECTRIC**  
LITHIUM ION

# EASY TO USE. EVEN EASIER TO OWN.

The benefits of electric equipment compared to petrol are beyond mowing your lawn. More flexibility, less time servicing and no more trips to the petrol station frees up time to enjoy the lawn you love.

## ▶ Cuts Like Petrol Models

Think electric equipment compromises power? Think again. Our lithium-ion powered electric lineup is designed to deliver a quality cut that you would expect from any Cub Cadet.

## ▶ Power Until The End

Our lithium-ion battery pack is designed to help minimise power fade, while the efficient brushless motor helps provide optimal power.

## ▶ 100% Electric. 0% Compromise.

Our electric lineup is engineered to meet the same rigorous Cub Cadet standards for performance, power and durability you'll find in any Cub Cadet equipment.

## ELECTRIC RIDE ONS & ZERO TURN

- CC30 E, XT1 LT42 E & ULTIMA ZT1 42E

(See page 47 for full specifications)



• CC30 E



• XT1 LT42 E



• ULTIMA ZT1 42E



### LITHIUM ION BATTERY RUN TIMES

- CC30 E: run time of up to 1 acre per full charge
- XT1 LT42 E: run time of up to 1.5 acres per full charge
- ULTIMA ZT1 42E: run time of up to 2 acres per full charge



### WARRANTY

6-year unit domestic warranty. 90-day unit commercial warranty.  
6-year engine domestic warranty. 90-day engine commercial warranty.





RESIDENTIAL: ELECTRIC RANGE

**ELECTRIC**  
LITHIUM ION

*Cub Cadet*



# PRO SERIES

It's easy to stick with what you know.

But real progress starts with doing something **different**.

**Different** isn't afraid to stand out.

**Different** doesn't back down from an uphill battle.

**Different** pushes the limits of what's possible.

**Different** is the beating heart of innovation.

The Pro Series by Cub Cadet®

# BUILT DIFFERENT

[cubcadet.com.au/commercial-mowers](http://cubcadet.com.au/commercial-mowers)





# PRO Z™ SERIES

## Your difference maker.

It takes a different kind of person to do what you do. And a different kind of machine. The PRO Z Series was built for exactly that. Maintenance-free spindles and commercial-grade engine options amp up your productivity, while fully welded frames and tough fabricated decks were engineered to stand up to tough demands for years to come.

The PRO Z Series offers category-exclusive steering systems engineered to tackle challenging terrain with up to a 20-degree incline. Add it to your crew and see the PRO Z difference for yourself.



### What makes the Pro Z™ Series?

CATEGORY-EXCLUSIVE STEERING SYSTEMS  
**STEERING WHEEL CONTROL**

COMMERCIAL-GRADE STRENGTH  
**7-GAUGE STEEL DECK\***

EASY AND QUICK DECK ADJUSTMENTS  
**ELECTRONIC POWER DECK LIFT SYSTEM#**

HILLSIDE STABILITY  
**REAR DUAL-WHEEL TRACTION†**

ADDED SAFETY  
**ROLLOVER PROTECTION**

\*Available on the PRO Z 700 & 900 Series. #Available on the PRO Z 900 Series. †Standard on the PRO Z 972 SD and PRO Z 972 SDL. Product images are for illustration purposes. Product specifications may change at anytime without prior notice.

**STRONG RESULTS  
WITH STEERING  
CONTROL.**





## PRO Z 100 S

ENGINE:  
25HP\* Kohler Confident, EFI

TRANSMISSION:  
Dual Hydro-Gear ZT-3400 Transmissions

DECK:  
122cm (48"), fabricated steel

TYRES (FRONT / REAR):  
13.00 x 6.50 (Smooth) / 23.00 x 10.50 (Turf)

WARRANTY:  
Unit: 3-year domestic & 3 year commercial.  
Engine: 3-year domestic & 3 year commercial.



## PRO Z 500 S

ENGINE::  
31HP\* Kawasaki

TRANSMISSION:  
HTJ Parker 12cc pumps & 260cc wheel motors

DECK:  
152cm (60"), fabricated steel

TYRES (FRONT / REAR):  
15.00 x 6.00 (Kenda) / 24.00 x 12.00 (Kenda Performance Tread)

WARRANTY:  
Unit: 3-year domestic & 3 year commercial.  
Engine: 3-year domestic & 3 year commercial.

## PRO Z ATTACHMENTS

Attachments Sold Separately.



### Power Assist Collection System

Quick and easy to install, the Power Assist Collection System performs well under tough conditions (PRO Z 100 S double bagger shown).



### Mulch kit

Mulching your lawn clippings allows for quick decomposition and returns essential nutrients back to the yard.

\*Engine HP is set by the engine manufacturer.  
Product images are for illustration purposes. Product specifications may change at anytime without prior notice.

**HEAVY-DUTY  
STRENGTH AND  
DURABILITY.**







## PRO Z 700 S

ENGINE:  
31HP\* Kawasaki

TRANSMISSION:  
HTG Parker 14cc pumps & 280cc wheel motors

DECK SIZE:  
152cm (60"), fabricated steel

TYRES (FRONT / REAR):  
13.00 x 6.50 (Reliance Carlisle) / 24.00 x 12.00 (Kenda Performance)

WARRANTY:  
Unit: 3-year domestic & 3 year commercial.  
Engine: 3-year domestic & 3 year commercial.



## PRO Z 900 S

ENGINE:  
35HP\* Kawasaki

TRANSMISSION:  
HTG Parker 16cc pumps and 310cc wheel motors

DECK SIZE:  
183cm (72"), fabricated steel

TYRES (FRONT / REAR):  
16.00 x 6.50 (Kenda K505) / 26.00 x 12.00 (Kenda Performance Tread)

WARRANTY:  
Unit: 3-year domestic & 3 year commercial.  
Engine: 3-year domestic & 3 year commercial.

## PRO Z ATTACHMENTS

Attachments Sold Separately



### Power Assist Collection System

Quick and easy to install, the Power Assist Collection System performs well under tough conditions (PRO Z 700 S only).



### Mulch kit

Mulching your lawn clippings allows for quick decomposition and returns essential nutrients back to the yard.

\*Engine HP is set by the engine manufacturer.  
Product images are for illustration purposes. Product specifications may change at anytime without prior notice.

# PRO Z™ DUAL-WHEEL SERIES

## Hillside stability solved.

You never back down from a challenge. That's why the PRO Z SD and SDL are dual-wheel commercial zero-turns specifically engineered to tackle challenging terrain with up to a 25-degree slope. And with up to 30 degrees of self-leveling air-ride seat comfort (exclusive to the SDL) these mowers are built to tackle properties with hilly and varying terrain.



### DUAL REAR WHEELS

Oversized dual rear wheels provide stability, traction and precision on the 972 SD and SDL.



## PRO Z 972 SD

HORSEPOWER:  
35HP\* Kawasaki

SEAT SWIVEL:  
-

WARRANTY:  
Unit: 3-year domestic & 3 year commercial.  
Engine: 3-year domestic & 3 year commercial.



## PRO Z 972 SDL

HORSEPOWER:  
35HP\* Kawasaki

SEAT SWIVEL:  
Self-leveling air-ride seat

WARRANTY:  
Unit: 3-year domestic & 3 year commercial.  
Engine: 3-year domestic & 3 year commercial.

## HILLSIDE CONFIDENCE

Four-wheel steering control with power steering increases productivity and hillside confidence for the ultimate in manoeuvrability.

- A** Up to a 25-degree slope
- B** Category exclusive steering wheel control with power steering
- C** Dual wheel traction control

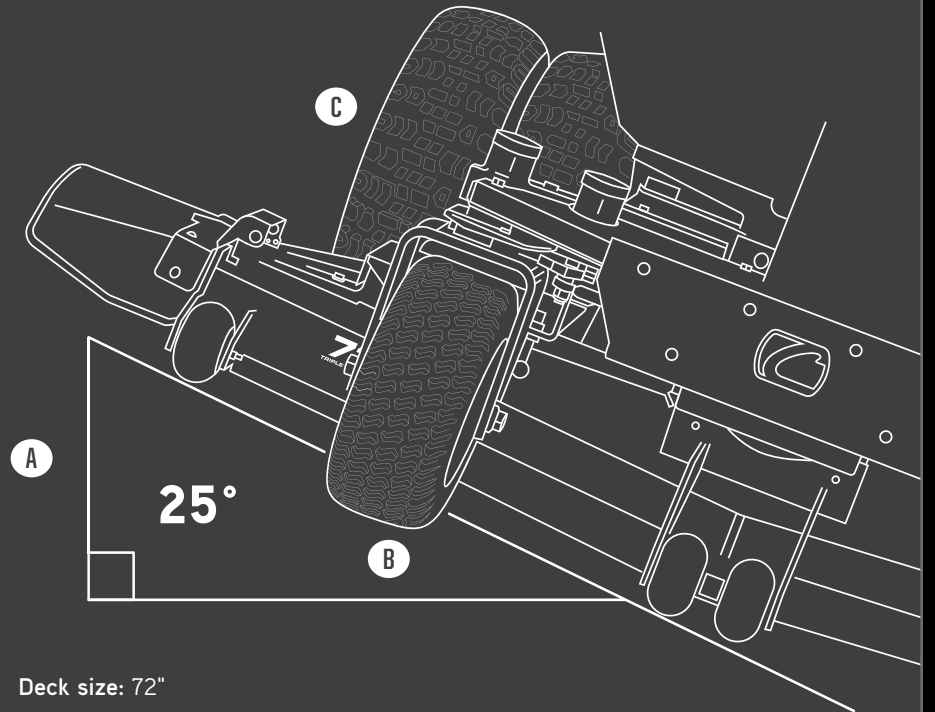

Deck size: 72"

## MAXIMISED COMFORT

The self-leveling air-ride seat on the PRO Z 972 SDL lets you operate with up to 15 degrees of self-leveling from side to side.

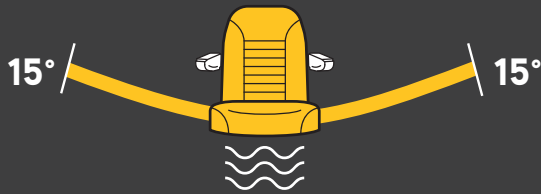

\*Engine HP is set by the engine manufacturer. Product images are for illustration purposes. Product specifications may change at anytime without prior notice.

# PRO Z™ COMFORT

## A different level of comfort.

When days are as long as yours, comfort isn't just nice to have—it's necessary. That's why we designed the PRO Z Series to be a smooth ride. Innovative features like the isolation dampening system and air-ride suspension help absorb impacts of the job, while adjustable seat firmness (PRO Z 900 Series only), lumbar support and padded armrests provide additional comfort so you'll be able to go the distance.



## PRO Z AIR-RIDE SEAT

Our air-ride seat allows riders to adjust seat firmness to their personal preference. Standard on the PRO Z 900.

- A** Air-ride control
- B** EVC cushion (elastic vibration control)
- C** Isolation-dampening system
- D** Angle-back adjustment
- E** Adjustable padded armrests
- F** Adjustable lumbar support

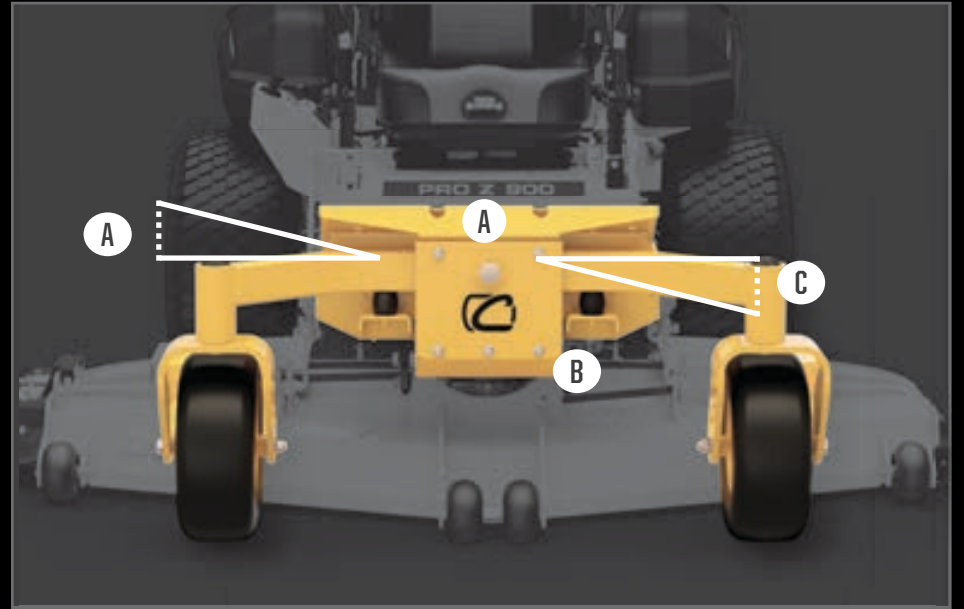

## PIVOTING FRONT AXLE WITH ISOLATION-DAMPENING SYSTEM MOUNTS

A pivoting front axle allows the front end of the PRO Z to ride across uneven terrain while helping protect the quality of the cut.

The frame and axle float as the PRO Z moves, allowing the deck to follow the shape of the terrain and help avoid scalping.

- A** 2 1/4" of travel  
(4 1/2" of total travel)
- B** Isolation-dampening system  
(standard on the PRO Z 900 Series)
- C** Maximum angle of travel up to 6 degrees

# PRO Z™ STRENGTH

**Strength without compromise.**

You expect the best and the PRO Z Series deck delivers.

Fully fabricated and triple plated steel thickness with top and bottom reinforcements—so you can power through the rigors of your job, day in and day out.



## DECKS BUILT TO LAST

Tackle tough conditions with a triple-7-gauge steel cutting deck: a 7-gauge deck shell with 7-gauge top and bottom reinforcements.

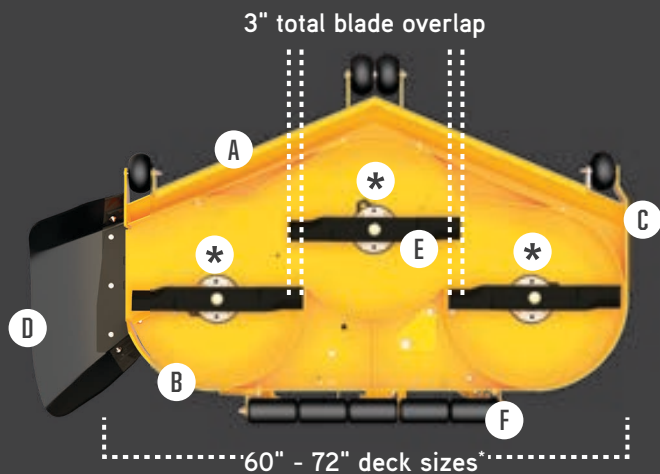

\*PRO Z 700 & 900 Series.

### Durability

- A** 1/4" leading rolled edge
- B** 5/16" steel side reinforcements
- C** 3/4" wear guard
- \*** Maintenance-free spindle assembly

### Quality Cut

- D** Flexible rubber discharge chute
- E** High-lift Marbain® blades  
(with blade tip speed up to 18,500 fpm)
- F** Adjustable rear striping roller  
(standard on the PRO Z 900 Series)

## HARD-WORKING FRONT END

Help absorb the impact of rough terrain with new front-end construction featuring a combination of axle, hub and yoke size.

- A** 2" x 3" pivoting front axle
- B** Isolation-dampening system  
(standard on the PRO Z 900 Series)
- C** 5" steel hubs
- D** 1/2" thick steel front yokes
- \*** Sealed maintenance-free ball bearings

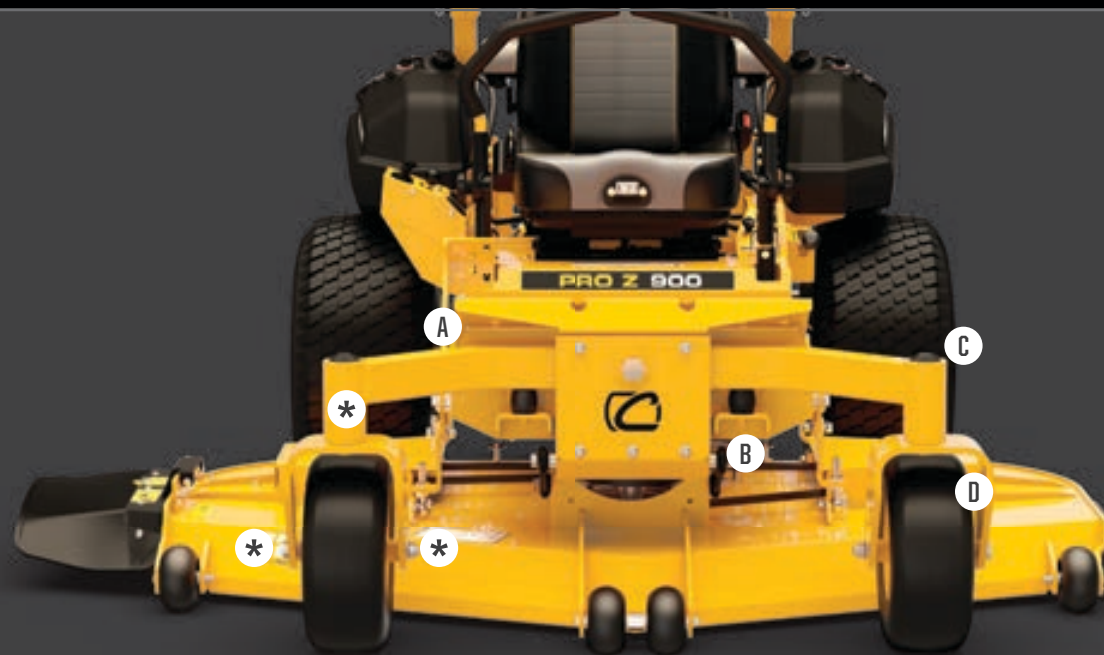

# PRO Z™ PERFORMANCE

## Built to meet high standards.

High standards like yours need high performance. That's why the PRO Z Series was engineered for consistent cut quality, in varying conditions. Featuring high-torque, commercial transmissions and high-horsepower, commercial-grade engines for optimal blade tip speed—and precise, single passes through thick grass.

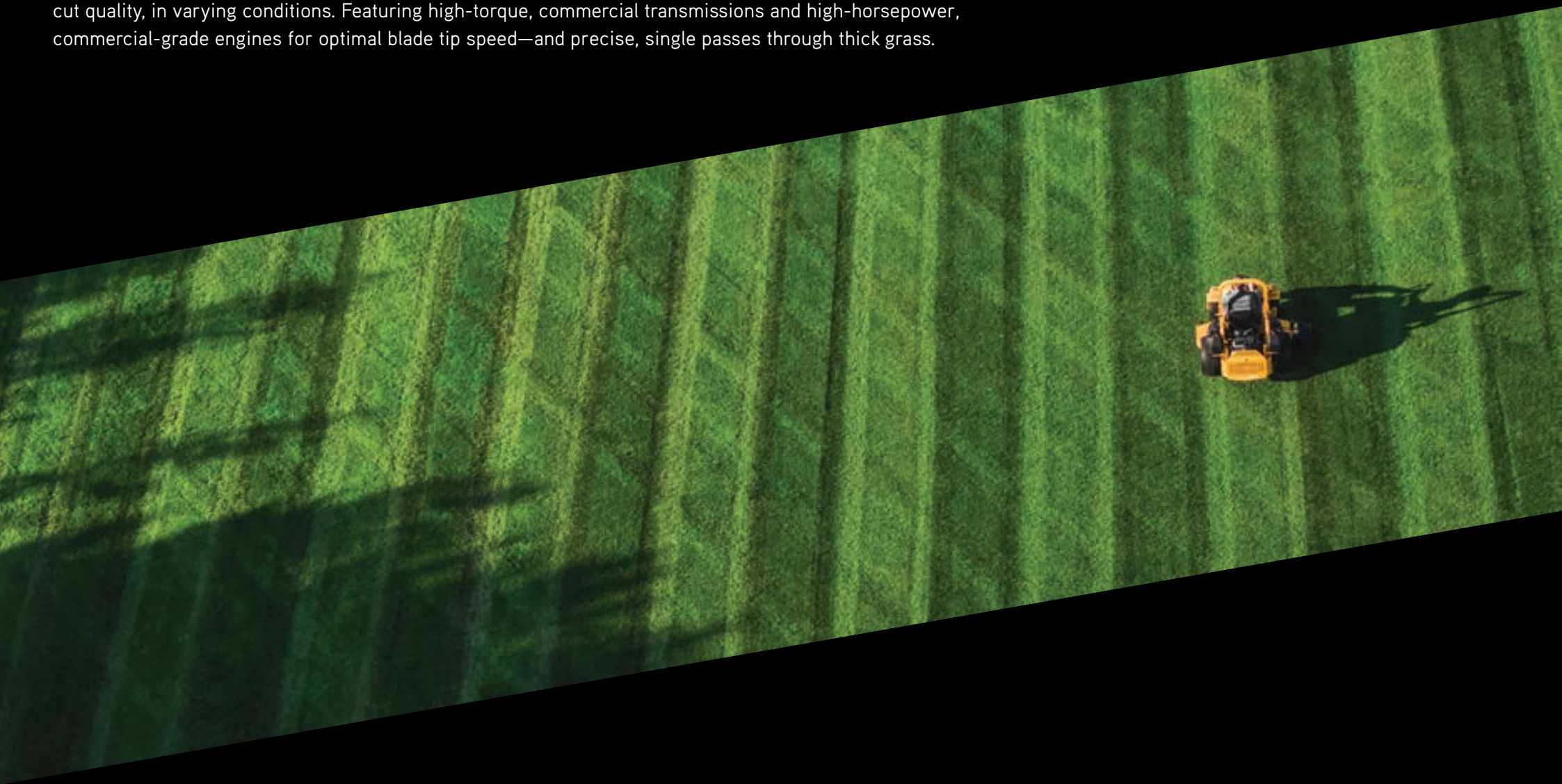



## POWERFUL KAWASAKI® ENGINES



### EFI engine technology available on select models\*

- ▶ Designed to deliver excellent horsepower
- ▶ Optimal balance of torque and power
- ▶ Maximum blade tip speed up to 18,500 fpm

Shown above:  
Kawasaki FX Series 35HP\*\* (999cc).

## MAX SPEED

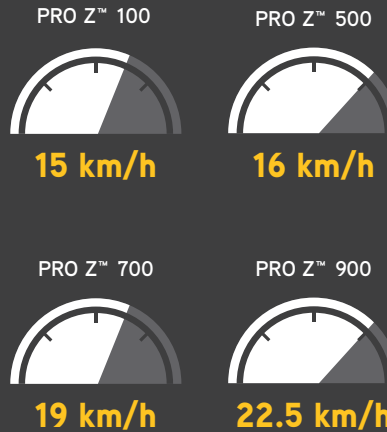

Maximum forward speeds.

## COMMERCIAL-QUALITY CUT AT HIGH SPEEDS

High-lift Marbain® blades with blade tip speed up to 18,500 fpm

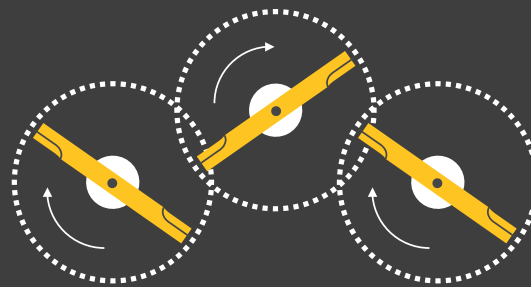

3" total blade overlap

Helps save time by cutting more grass in one pass.

## COMMERCIAL ENGINE HORSEPOWER AND TORQUE

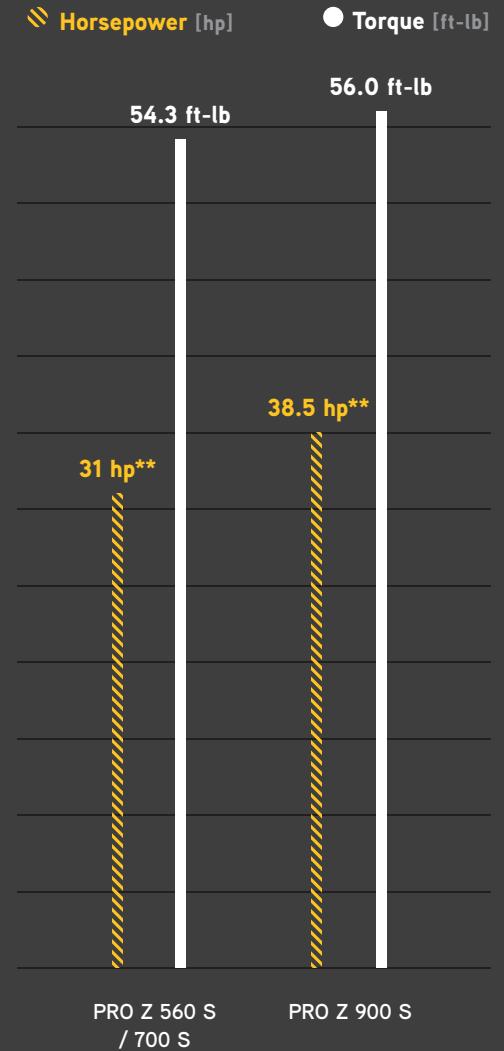

\*EFI available on PRO Z 100 S Series. \*\*Engine HP is set by the engine manufacturer. Product images are for illustration purposes. Product specifications may change at anytime without prior notice.



# PRO X™ SERIES

## Different done better.

Seize productivity with the latest addition to the Cub Cadet professional line up. The PRO X 648 gives you the zero turn flexibility you need to mow a wider range of properties.

The easy-to-adjust suspension platform accommodates any operator while the smooth and highly responsive controls allow for less vibration and peak manoeuvrability, maximising your productivity and comfort.



### What makes the Pro X™ Series?

COMPACT FOOTPRINT

**OCCUPIES LITTLE TRAILER SPACE**

EXCELLENT GROUND CLEARANCE

**24-INCH TYRES**

OPTIMAL PERFORMANCE

**INTUITIVE MANOEUVRABILITY**







IMPACT ABSORPTION

**ADJUSTABLE SUSPENSION**

STRENGTH WITHOUT COMPROMISE

**ULTRA-COMFORTABLE RIDE**

<b>ENDURO SERIES</b>	<b>XT1 LT 42</b>	<b>XT2 LX 42 (KAWASAKI)</b>	<b>XT2 LX 42 (EFI)</b>	<b>XT2 LX 46 (EFI)</b>
<b>ENGINE</b>				
Engine Type	547cc Cub Cadet Single OHV w/IntelliPower™	24HP Kawasaki® V-Twin OHV	679cc Cub Cadet V-Twin OHV, EFI	
Fuel Tank Capacity	11.4 litres		9.5 litres	
<b>DRIVE SYSTEM</b>				
Transmission	Hydro, Foot (Tuff Torq)		Auto-Diff Hydro, Foot (Tuff Torq)	
Forward / Reverse Speeds	8.6km/h / 4.8km/h			
<b>CONTROLS</b>				
Steering Control	Standard steering wheel			
Start Type	Key		Push Button Start (PBS)	
Mow In Reverse	Standard			
<b>CUTTING DECK</b>				
Deck Construction	13-gauge pressed steel	11-gauge fabricated steel		
Cutting Width / Blades	107cm (42") / twin blade		117cm (46") / twin blade	
Height Adjustment	12-positions / 2.5cm - 10cm (1" - 4")			
Deck Blade Engagement	Manual, lever	Electronic fingertip engagement allows you to easily engage and disengage the mowing deck saving you time and energy		
Deck Wash	Patented SmartJet™ high-pressure deck washing system			
<b>CHASSIS</b>				
Frame	Fully robotically welded frame			
Front / Rear Tyres	15.00 x 6.00 (Turf Saver) / 20.00 x 8.00 (Turf Saver)	15.00 x 6.00 (Multi-Trac) / 20.00 x 8.00 (Multi-Trac)		
<b>COMFORT</b>				
Seat	High-back	High-back with armrests		
<b>ADDITIONAL FEATURES</b>				
Additional Features	Turning radius 41cm (16")			
<b>WARRANTY</b>				
Warranty	Unit: 6-year domestic and 90 day commercial / Engine: 6-year domestic and 90 day commercial			

<b>ACCESSORIES</b>					
					
Mulch Kit 42" Deck Fits XT1 LT 42 # 19A70041OEM	Mulch Kit 42" Deck Fits XT2 LX 42 models # 19B30054100	Mulch Kit 46" Fab Deck Fits XT2 LX46 # 19A30047100	Double Bagger Catcher Fits XT1 LT 42 & XT2 LX 42/46 # 19B30031OEM	4 Litre 4-Stroke Oil 10W30 # 333-000-0004	20 Litre 4-Stroke Oil 10W30 # 330-000-0010

	ZT1 42	ZT1 46	ZT2 54	ZTS1 42	ZTS1 46
<b>ENGINE</b>					
Engine Type	21.5HP Kawasaki® FR651v V-Twin OHV	23HP Kawasaki® FR651v V-Twin OHV		679cc Cub Cadet V-Twin OHV	
Fuel Tank Capacity	13.2 litres, centre mounted				
<b>DRIVE SYSTEM</b>					
Transmission	Dual Hydro-Gear® EZT-2200		Dual Tuff-Torq TZ-350-F	Dual Hydro-Gear® EZT-2200	
Forward / Reverse Speeds	Up to 11.3km/h / 5.6km/h		Up to 11km/h / 5km/h	Up to 11km/h / 5.6km/h	
<b>CONTROLS</b>					
Steering Control	Over-molded soft-touch ergo grip lap bars with integrated parking brake system			Steering wheel with Synchro-Steer™ technology	
<b>CUTTING DECK</b>					
Deck Construction	11-gauge AeroForce™, fabricated steel		11-gauge AeroForce™ flat top deck, fabricated steel	11-gauge AeroForce™, fabricated steel	
Cutting Width / Blades	107cm (42") / twin blade	117cm (46") / twin blade	137cm (54") / triple blade	107cm (42") / twin blade	117cm (46") / twin blade
Deck Blade Engagement	Electronic fingertip engagement				
Deck Lift / Height	Foot-operated / 15-position / dial adjust / 2.5cm - 11.4cm (1" - 4.5")				
<b>CHASSIS</b>					
Frame / Front Castor Mounts	Square 5cm x 5cm (2" x 2") tubular upper and lower frame structure / Rectangular 5cm x 6cm (2" x 2.5") square frame / offset				
ROPS	N/A				
Front / Rear Tyres	11.00 x 6.00 (smooth) / 20.00 x 8.00 (Turf Master)		13.00 x 6.50 (smooth) / 20.00 x 12.00 (Turf Master)	13.00 x 6.50 (Turf Master) / 20.00 x 8.00 (Turf Master)	
<b>COMFORT</b>					
Seat	Premium high-back adjustable seat with suspension		Premium high-back adjustable seat with cushioned armrests & ball-bearing seat slide		
Floor Mat	Rubber				
<b>ADDITIONAL FEATURES</b>					
Additional Features	Dual LED headlights, multi-tool and removable floor pan				
<b>WARRANTY*</b>					
Warranty	Unit: 3-year domestic and 90 day commercial / Engine: 3-year domestic and 90 day commercial. 5-year fabricated deck shell.				

## ACCESSORIES



Mulch Kit 42" Deck  
Fits ZT1 42 & ZTS1 42  
# 19B30054100



Mulch Kit 46" Fab Deck  
Fits ZT1 46 & ZTS1 46  
# 19A30047100



Mulch Kit 54" Fab Deck  
Fits ZT2 54  
# 19A30051100



Double Bagger Catcher  
Fits ZT1 42/46 & ZTS1 42/46  
# 19B70054100



ZTS1 42/46 Adapter Kit  
Required to mount catcher  
# 490-950-C062



Triple Bagger Catcher  
Fits ZT2 54  
# 19A70056100



Lawn Striping Kit  
Fits ZT1 42 & ZT2 54  
# 19A700600EM (42") / 19A700590EM (54")

# ULTIMA

## ZTX5 48

## ZTX5 54

## ZTX5 60

### ENGINE

Engine Type	23HP Kawasaki® FR691v V-Twin OHV	24HP Kawasaki® FR730v V-Twin OHV	
Fuel Tank Capacity	Fuel Tank 20.8 litres, centre mounted		

### DRIVE SYSTEM

Transmission	Dual Hydro-Gear® EZT-3200		
Forward / Reverse Speeds	Up to 13km/h / 5km/h		Up to 13km/h / 6km/h

### CONTROLS

Steering Control	Over-molded soft-touch ergo grip lap bars with integrated parking brake system		
------------------	--	--	--

### CUTTING DECK

Deck Construction	10-gauge AeroForce Max™ fabricated steel deck with 2-gauge reinforcement and 7-gauge side wraps plus skid plate		
Cutting Width / Blades	122cm (48") / triple blade	137cm (54") / triple blade	152cm (60") / triple blade
Deck Blade Engagement	Electronic fingertip engagement		
Deck Lift / Height	Foot operated / 16-position / dial adjust / transport mode / 2.5cm - 12cm (1" - 4.75")		

### CHASSIS

Frame / Front Castor Mounts	Rectangular 4cm x 8cm (1.5" x 3") tubular upper and lower frame structure / Rectangular 4cm x 8cm tubular frame / offset / front caster suspension		
ROPS	Foldable, Roll Over Protection System designed to keep you safe when mowing on difficult terrain		
Front / Rear Tyres	13.00 x 6.50 (Smooth) / 23.00 x 12.00 (Turf Master)		

### COMFORT

Seat	Premium automotive class high-back adjustable seat with cushioned armrests, ball-bearing seat slide and patented suspension system		
Floor Mat	Rubber		

### ADDITIONAL FEATURES

Additional Features	Cup holder, dual LED headlights and removable floor pan		
---------------------	---	--	--

### WARRANTY

Warranty	Unit: 3-year domestic and 2-year commercial / Engine: 3-year domestic and 2-year commercial. 5-year fabricated deck shell.		
----------	--	--	--

### ACCESSORIES



Mulch Kit 48" Fab Deck  
Fits ZTX5 48  
# 19B70064100



Mulch Kit 54" Fab Deck  
Fits ZTX5 54  
# 19B70065100



Mulch Kit 60" Fab Deck  
Fits ZTX5 60  
# 19B70066100



Triple Bagger Catcher  
Fits ZTX5 48  
# 49A70001100



Triple Bagger Catcher  
Fits ZTX5 54/60  
# 49A70002100

ENGINE			
Engine Type	23HP Kawasaki® FR961v V-Twin OHV	24HP Kawasaki® FR730v V-Twin OHV	25.5HP Kawasaki® FX801v V-Twin OHV
Fuel Tank Capacity	Fuel Tank 20.8 litres, centre mounted		
DRIVE SYSTEM			
Transmission	Dual Hydro-Gear® ZT-3100		Dual Hydro-Gear® ZT-3200
Forward / Reverse Speeds	Up to 12.9km/h / 5.6km/h		Up to 13.7km/h / 5.6km/h
CONTROLS			
Steering Control	Steering wheel with Synchro-Steer™ technology		
CUTTING DECK			
Deck Construction	10-gauge AeroForce Max™ fabricated steel deck with 2-gauge reinforcement and 7-gauge side wraps plus skid plate		
Cutting Width / Blades	122cm (48") / triple blade	137cm (54") / triple blade	152cm (60") / triple blade
Deck Blade Engagement	Electronic fingertip engagement		
Deck Lift / Height	Foot operated / 16-position / dial adjust / transport mode / 2.5cm - 12cm (1" - 4.7")		
CHASSIS			
Frame / Front Castor Mounts	Rectangular 4cm x 8cm (1.5" x 3") tubular upper and lower frame structure / Rectangular 4cm x 8cm tubular frame / offset		
ROPS	Foldable, Roll Over Protection System designed to keep you safe when mowing on difficult terrain		
Front / Rear Tyres	13.00 x 6.50 (Turf Master) / 22.00 x 12.00 (Turf Master)	13.00 x 6.50 (Turf Master) / 23.00 x 12.00 (Turf Master / Multi Trac)	
COMFORT			
Seat	Premium automotive class 50.8cm (20") high-back adjustable seat with cushioned armrests, ball-bearing seat slide and suspension system	Premium automotive class 61cm (24") high-back adjustable seat with cushioned armrests, ball-bearing seat slide and suspension system	
Floor Mat	Rubber		
ADDITIONAL FEATURES			
Additional Features	Cup holder, dual LED headlights and removable floor pan		
WARRANTY			
Warranty	Unit: 3-year domestic and 2-year commercial / Engine: 3-year domestic and 2-year commercial. 5-year fabricated deck shell.		

### ACCESSORIES



Mulch Kit 48" Fab Deck  
Fits ZTXS4 48  
# 19B70064100



Mulch Kit 54" Fab Deck  
Fits ZTXS4 54 & ZTXS5 54  
# 19B70065100



Mulch Kit 60" Fab Deck  
Fits ZTXS5 60  
# 19B70066100











Triple Bagger Catcher  
Fits ZTXS4 48  
# 49A70001100



Triple Bagger Catcher  
Fits ZTXS4 54 & ZTXS5 54/60  
# 49A70002100

<b>ELECTRIC</b>	<b>CC 30 E</b>	<b>Enduro Series XT1 LT42 E</b>	<b>ULTIMA ZT1 42E</b>
<b>POWER</b>			
Power Source / Battery	56V MAX 1,500Wh-30Ah / Lithium-ion battery	56V MAX 3,000Wh-60Ah / Lithium-ion battery	56V MAX 3,000Wh-60Ah / Lithium-ion battery
Run Time	Up to 1 hour or 1 acre	Up to 1.5 hours or 2 acres	
Charger	110V anytime fast charger (4 hours to full charge)		
<b>DRIVE SYSTEM</b>			
Transmission	Foot-controlled electric drive		Dual 56V electric drive
Forward / Reverse Speeds	Up to 6.4km/h / 3.2km/h	Up to 8.8km/h / 4.8km/h	Up to 11.2 km/h / 4.8km/h
<b>CONTROLS</b>			
Steering Control	Optimised steering system, sector and pinion	Optimised steering system, sector and pinion	Ergonomic lap bars
Mow In Reverse	Standard		
<b>CUTTING DECK</b>			
Deck Construction	14-gauge stamped steel deck	13-gauge stamped steel deck	13-gauge direct-drive steel deck
Cutting Width / Blades	76cm (30") / single blade	107cm (42") / twin blade	
Height Adjustment	5-position / 3.8cm - 10cm (1.5" - 4")	12-position / 2.5cm - 10cm (1" - 4")	15-position / 2.5cm - 11.4cm (1" - 4.5")
Deck Blade Engagement	Electric PTO	Electronic fingertip engagement allows you to easily engage and disengage the mowing deck saving you time and energy	
<b>CHASSIS</b>			
Frame	14-gauge welded steel	13-gauge fully robotically welded frame	Square 5cm x 5cm (2" x 2") tubular upper and lower frame structure
Front / Rear Tyres	13.00 x 5.00 (Turf Saver) / 16.00 x 6.50 (Turf Saver)	15.00 x 6.00 (Turf Saver) / 20.00 x 8.00 (Turf Saver)	11.00 x 600 (Smooth) / 20.00 x 8.00 (Turf Master)
<b>COMFORT</b>			
Seat	15" Cub Comfort™ high-back seat / knob adjust	15" Cub Comfort™ deluxe high-back seat / 10 seat slide	20" premium high-back adjustable seat with suspension
<b>ADDITIONAL FEATURES</b>			
Additional Features	Cup holder, dual LED headlights, USB port & front bumper	Cup holder, dual LED headlights, USB port & front bumper	Cup holder, dual LED headlights, multi-tool, removable floor pan, USB port
<b>WARRANTY</b>			
Warranty	Unit: 6-year domestic and 90 day commercial / Engine: 6-year domestic and 90 day commercial		

<b>ACCESSORIES</b>								
								
Arm Rest Kit Fits CC 30 E & ZT1 42E # 759-04252	Arm Rest Kit Fits XT1 LT42 E # 757-06093	Mulch Kit - 30" Deck Fits CC 30 E # 19A30013OEM	Catcher 30" Deck Fits CC 30 E # 19A30014OEM	Mulch Kit 42" Deck Fits XT1 LT42 E & ZT1 42 E # 19A30055100	Double Bagger Catcher Fits XT1 LT42 E # 19A30031100	Fast Attach Cargo Carrier Fits XT1 LT42 E # 19B30029100	FastAttach Brush Guard Fits XT1 LT42 E # 19A30038100	FastAttach Sun Shade Fits XT1 LT42 E # 490-900-0067



## PRO Z 100 / 500 S

## PRO Z 148 S

## PRO Z 560 S

ENGINE		
Engine Type	27HP Kohler® Confidant V-Twin OHV EFI EZT-740	31HP Kawasaki FX921V V-Twin OHV
Fuel Tank Capacity	Twin 13.25 litre fuel tanks - 26.5 litres in total	Twin 28.4 litre fuel tanks - 56.8 litres total to keep you mowing longer
DRIVE SYSTEM		
Transmission	Commercial-grade Dual Hydro-Gear® ZT-3400 Transmissions	HTJ Parker 12cc pumps and 260cc wheel motors
Forward / Reverse Speeds	Up to 15 km/h / 7km/h	Up to 16 km/h / 8km/h
CONTROLS		
Steering Control	Four-wheel steering with steering wheel control	High performance steering wheel with electronic power steering and foot-pedal control
Mow In Reverse	Standard	
CUTTING DECK		
Deck Construction	Floating, fabricated 10-gauge (0.135") steel shell (e-coat)	Floating, fabricated 7-gauge top plate, 7-gauge bottom reinforcements, 1/4" rolled leading edge
Cutting Width	122cm (48") / triple blade	152cm (60") / triple blade
Height Adjustment	15-position / 2.5cm - 12.7cm (1" - 5")	16-positions / 2.5cm - 12.7cm (1" - 5")
Deck Blade Engagement	Warner® clutch - 125 Ft Lb	Warner PTO clutch (200 ft-lb)
CHASSIS		
Frame	Fully-welded, full length 12-gauge channel frame with 14-gauge reinforcements	Fully-welded, full-length 3/8 x 5" laser cut steel / integrated tie-down slots
Front / Rear Tyres	13.00 x 6.50 (Turf) / 23.00 x 10.50 (Carlisle Turf Master)	15.00 x 6.00 (Kenda) / 24.00 x 12.00 (Kenda Performance Tread)
ROPS	Foldable, 3-position Roll Over Protection System designed to keep you safe when mowing on difficult terrain	
COMFORT		
Seat	High-back EVC comfort seat with armrests, dial suspension, seat belt and 15cm (6") of seat travel	High-back dial suspension with EVC cushion, adjustable angle back and padded arm rests, lumbar adjustment and ISO mounts
ADDITIONAL FEATURES		
Additional Features	Rear hitch standard	
WARRANTY		
Warranty	Unit: 3-year domestic and 2-year commercial / Engine: 3-year domestic and 3-year commercial. 5-year fabricated deck shell.	Unit: 3-year domestic and 3-year commercial / Engine: 3-year domestic and 3-year commercial. 5-year fabricated deck shell.

### ACCESSORIES





Mulch Kit 48" Deck  
Fits PRO Z 148 S  
# 19B70037100



Mulch Kit 60" Deck  
Fits PRO Z 560 S  
# 19A70039100



PRO Z 700 S / 900 S	PRO Z 760 S	PRO Z 972 S	PRO Z 972 SD	PRO Z 972 SDL
<b>ENGINE</b>				
Engine Type	31HP Kawasaki® FX921v V-Twin OHV, 999cc		35HP Kawasaki® FX1000 V-Twin OHV, 999cc	
Fuel Capacity	Twin 28 litre fuel tanks - 56 litres in total to keep you mowing longer			
<b>DRIVE SYSTEM</b>				
Transmission	14cc Parker HTG pump with hydro release lever		16cc Parker HTG pumps and 310cc wheel motors	
Forward / Reverse Speeds	Up to 19 km/h / 9.5km/h		Up to 22.5 km/h / 9.5km/h	
<b>CONTROLS</b>				
Steering Control	High performance steering wheel with electronic power steering and foot-pedal control			
Mow In Reverse	Standard			
<b>CUTTING DECK</b>				
Deck Construction	Floating, fabricated 7-gauge top plate, 7-gauge bottom reinforcements, 1/4" rolled leading edge			
Cutting Width	152cm (60") / triple blade		183cm (72") / triple blade	
Height Adjustment	16-positions / 2.5cm - 12.7cm (1" - 5")		16-position / 2.5cm - 12.7cm (1" - 5") with electronic power deck lift system	
Deck Blade Engagement	Warner PTO clutch (200 ft-lb)		Warner® PTO clutch - 225 Ft Lb with Soft-Start	
<b>CHASSIS</b>				
Frame	Fully-welded, full-length 3/8 x 5" laser cut steel / integrated tie-down slots			
Front / Rear Tyres	16.00 x 6.50 (Reliance Carlisle Run-Flat) / 24.00 x 12.00 (Kenda Performance)		16.00 x 6.50 (Kenda K505) / 26.00 x 12.00 (Kenda) / 16.00 x 6.50 (Kenda K505) / 25.00 x 9.00 (HD Traction Tread)	
ROPS	Foldable, 3-position Roll Over Protection System designed to keep you safe when mowing on difficult terrain			
<b>COMFORT</b>				
Seat	High-back dial suspension with EVC cushion, adjustable angle back and padded arm rests, lumbar adjustment and ISO mounts		High-back, quick adjust Air Ride suspension with EVC cushion, adjustable angle back and padded arm rests, lumbar adjustment and ISO mounts	
<b>ADDITIONAL FEATURES</b>				
Additional Features	Rear hitch standard			
<b>WARRANTY</b>				
Warranty	Unit: 3-year domestic and 3-year commercial / Engine: 3-year domestic and 3-year commercial. 5-year fabricated deck shell.			

ACCESSORIES		
		
Mulch Kit 60" Deck Fits PRO Z 760 S # 19B70039100	Mulch Kit 72" Deck Fits PRO Z 900 S/SD/SDL # 59C30053150	Power Assist Triple Bagger Catcher Fits PRO Z 760 S # 59A30047150



## PRO X SERIES

## PRO X 648

ENGINE	
Engine Type	22HP Kawasaki® FX691v V-Twin OHV
DRIVE SYSTEM	
Transmission	12cc Hydro-Gear® pumps / 240cc Parker wheel motors
CUTTING DECK	
Deck Construction	10-gauge shell with 7-gauge top and bottom reinforcements
Cutting Width / Height	122cm (48") fabricated steel deck / 3.8cm (1-1/2") – 12.7cm (5")
Deck Blade Engagement	Electronic with quick reset
CHASSIS	
Frame	5cm (2") x 7.6 (3") full-length tube frame
ADDITIONAL FEATURES	
Additional Features	Electric starter, hour meter, fuel gauge, key switch, throttle, choke, 3-position operator cushion with cargo pocket and hand lever adjust, 3-position spring suspension foot platform
Front / Rear Tyres	13.00 x 5.00 (Reliance Run Flat Carlisle) / 24.00 x 9.50 (Kenda Performance Tread)
ACCESSORIES	
Optional Accessories	Mulch kit for 48" deck (# 19B70037100) / Power Assist Triple Bagger Catcher (#59A30060150)
WARRANTY	
Warranty	Unit: 3-year domestic and 3-year commercial / Engine: 3-year domestic and 3-year commercial. 5-year fabricated deck shell.

# ALSO AVAILABLE IN THE CUB CADET RANGE

## TRIMMER

## WHEELED STRING TRIMMER

ENGINE	
Engine Type	159cc Cub Cadet Engine, 4-stroke
CUTTING DECK	
Cutting Width / Height	56cm (22") / adjustable, 4.1cm (1.6") - 7.6cm (3")
WHEELS	
Wheel Type	35.6cm (14") ball bearing wheels
HANDLE	
Handle Type	Loop
WARRANTY	
Warranty	Unit: 2-year domestic and 90 day commercial / Engine: 2-year domestic and 90 day commercial



INDEPENDENT DEALER

*Cub Cadet*

# YOUR AUTHORISED CUB CADET DEALER MAKES YOUR EXPERIENCE EVEN BETTER.

Cub Cadet dealers know their equipment. And they know how to take care of it and their customers. You'll get exceptional financing, great offers and the expertise you can only find from professionals who sell and service Cub Cadet equipment every day.

## SUPPORT AS STRONG AS OUR MACHINES

Visit [cubcadet.com.au](https://cubcadet.com.au) or call 1300 951 594.



[facebook.com/cubcadetaus](https://facebook.com/cubcadetaus)



[@cubcadetaus](https://instagram.com/cubcadetaus)



[cubcadetaustralia](https://youtube.com/cubcadetaustralia)



For more information, please call **1300 951 594** or visit [www.cubcadet.com.au](https://www.cubcadet.com.au)

Images are for illustration purposes and may not reflect current dealer inventory or unit specifications. Product specifications may change at any time without prior notice. Please confirm product specifications in-store with your Cub Cadet Dealer prior to purchase. Not all products available at all dealers. A failure by a supplier to deliver in accordance with sample description or not at all or other unintentional causes may result in some products being unavailable. Engine descriptions, warranty and horsepower (HP) are by the engine manufacturer.

\*For more information on our warranty, please contact your local Cub Cadet Dealer. FEB25.